

# DRAWER



“  
Highly recommend!  
Works great, easy to  
install and quickly turns  
a messy “junk” drawer  
into a well organized,  
easy to use drawer.

- Chris

**PROP 65 WARNING FOR CALIFORNIA RESIDENTS**  
WARNING: These products can expose you to chemicals such as formaldehyde, lead or styrene, which are known to the State of California to cause cancer and birth defects or other reproductive harm. For more information go to [www.P65Warnings.ca.gov](http://www.P65Warnings.ca.gov)





Create a clutter-free home with the inventive selection of drawer accessories from Rev-A-Shelf. Organizing is simple with great products like our Cutlery Trays, Utensil Trays and Universal Spice Racks. We've even found a way to expand the space in your drawer with our unique two-tier system for cookware, cutlery and cosmetics. From the kitchen to the bathroom, Rev-A-Shelf Drawer Accessories furnish unlimited storage solutions for every room in your home.

# 4WTMD Series

## Tiered MAXX Drawer



SCAN FOR PRICING!



**blum**

- Designed for 24" base face frame cabinet drawers
- Complete drawer system, just add your drawer front
- Easy installation
- Natural maple construction with semi-gloss finish
- Full-extension, BLUM soft-close undermount slides
- 5/8" drawer side walls
- (5) drawer compartments
- Comes with (8) short dividers, (5) long dividers and (26) clips
- Mounts to cabinet drawer front, rear and sidewalls
- Figure 8 door mount brackets
- TSCA Title VI compliant

**JUST ADD  
YOUR OWN  
DRAWER  
FRONT!**



For video visit:  
[rev-a-shelf.com/videos](http://rev-a-shelf.com/videos)



SCAN FOR PRICING!



(2) upper sections pull up and away, for easy access to the items stored beneath



**4WTMD-24HSC-1**  
Tiered Maxx Drawer



Comes with (8) short dividers,  
(5) long dividers and (26) clips

**Tiered MAXX Drawer w/ BLUMOTION Soft-Close**

PRODUCT	DESCRIPTION	DIMS	MCO	CAB	FINISH	SLP
4WTMD-24HSC-1	Tiered Maxx Drawer	21" (533 mm) W x 21-17/32" (547 mm) D x 4-11/32" (111 mm) H	21" (533 mm)	B24	Maple	\$424.40



SCAN FOR PRICING!



- Designed for 30" and 36" base cabinet drawers
- Complete drawer system, just add your drawer front
- Easy installation
- Natural maple construction with semi-gloss finish
- Full-extension, BLUM soft-close undermount slides
- (3) drawer compartments
- Sliding top tray is designed for use with 4WCT, 4WUT and 4WKB inserts (sold separately, pgs. 214-220)
- Mounts to cabinet drawer front, rear and sidewalls
- Figure 8 door mount brackets
- US Patent No. D843,791
- TSCA Title VI compliant



4WTCDD-36HSC-1



**4WTCDD-30HSC-1 & 4WTCDD-724HFLSC-1**  
Tiered Deep Drawers  
(30" version shown)



Top tier compatible with our trimmable inserts



For video visit:  
[rev-a-shelf.com/videos](http://rev-a-shelf.com/videos)

#### Full Access Tiered Deep Drawer w/ BLUMOTION Soft-Close

PRODUCT	DESCRIPTION	DIMS	MCO	CAB	FINISH	SLP
4WTCDD-724HFLSC-1	Tiered Deep Drawer	28-1/2" (724 mm) W x 22-3/16" (564 mm) D x 8-1/32" (204 mm) H	28-1/2" (724 mm)	FLB30	Maple	\$561.00
4WTCDD-876HFLSC-1	Tiered Deep Drawer	34-1/2" (876 mm) W x 22-3/16" (564 mm) D x 8-1/32" (204 mm) H	34-1/2" (876 mm)	FLB36	Maple	\$581.30

#### Face Frame Tiered Deep Drawer w/ BLUMOTION Soft-Close

4WTCDD-30HSC-1	Tiered Deep Drawer	27" (686 mm) W x 22-1/4" (565 mm) D x 8-1/32" (204 mm) H	27" (686 mm)	FFB30	Maple	\$497.50
4WTCDD-36HSC-1	Tiered Deep Drawer	33" (838 mm) W x 22-1/4" (565 mm) D x 8-1/32" (204 mm) H	33" (838 mm)	FFB36	Maple	\$519.80



SCAN FOR PRICING!

# Charging Drawer

## 4WCDB Series

Waste

Blind Corner

Sink

Base

Tail

Drawer

Wall

Vanity

Closet

Lazy Susan

LED Lighting



- Designed for 18" base cabinet drawers
- Just add your drawer front
- Natural maple construction with semi-gloss finish
- Full-extension, BLUM soft-close undermount slides
- (2) 120V plugs and (2) 2.1 amp USB ports
- Tamper resistant outlets
- Max Current: AC: 12 amps @ 120VAC; USB 2.1 amp & 5VDC
- UL recognized to UL962/CSA-C22.2 No. 0-10
- Power cord with NEMA 5 - 15 plug
- Integrated cord guide to ensure safe operation
- Figure 8 door mounting brackets
- Shock absorbent mat, black
- Overall safety of this product is determined by its end use
- TSCA Title VI compliant

4WCDB-18HFLSC-1



**4WCDB-18HSC-1**  
Charging Drawer



Integrated cord guide to ensure safe operation mounts to cabinet side and rear wall



For video visit:  
[rev-a-shelf.com/videos](http://rev-a-shelf.com/videos)

### Full Access Charging Drawer w/ BLUMOTION Soft-Close

PRODUCT	DESCRIPTION	DIMS	MCO	CAB	FINISH	SLP
4WCDB-18HFLSC-1	Charging Drawer	16-1/2" (419 mm) W x 22-7/16" (570 mm) D x 4-5/16" (110 mm) H	16-1/2" (419 mm)	FLB18	Maple	\$600.60

### Face Frame Charging Drawer w/ BLUMOTION Soft-Close

4WCDB-18HSC-1	Charging Drawer	15" (381 mm) W x 22-3/4" (578 mm) D x 4-5/16" (110 mm) H	15" (381 mm)	FFB18	Maple	\$604.50
---------------	-----------------	--	--------------	-------	-------	----------



SCAN FOR PRICING!



4WTCD-18HSC-1

**blum**

- Designed for 15", 18", 21" and 24" base cabinet drawers
- Complete drawer system, just add your drawer front
- Easy installation
- Natural maple construction with semi-gloss finish
- Full-extension, BLUM soft-close undermount slides
- Drawer features up to (7) compartments
- Sliding top tray features up to (7) compartments
- Mounts to cabinet drawer front, rear and side walls
- Figure 8 door mount brackets
- TSCA Title VI compliant

**JUST ADD  
YOUR OWN  
DRAWER  
FRONT!**



For video visit:  
[rev-a-shelf.com/videos](https://rev-a-shelf.com/videos)



SCAN FOR PRICING!



**4WTCD-15H-1 & 4WTCD-15HSC-1**  
Face Frame Tiered Cutlery Drawer  
(15" version shown)



**4WTCD-18H-1 & 4WTCD-18HSC-1**  
Face Frame Tiered Cutlery Drawer  
(18" version shown)



**4WTCD-21H-1 & 4WTCD-21HSC-1**  
Face Frame Tiered Cutlery Drawer  
(21" version shown)



**4WTCD-24H-1 & 4WTCD-24HSC-1**  
Face Frame Tiered Cutlery Drawer  
(24" version shown)



**4WTCD-343HFL-1 & 4WTCD-343HFLSC-1**  
Full Access Tiered Cutlery Drawer  
(15" version shown)



**4WTCD-419HFL-1 & 4WTCD-419HFLSC-1**  
Full Access Tiered Cutlery Drawer  
(18" version shown)



**4WTCD-495HFL-1 & 4WTCD-495HFLSC-1**  
Full Access Tiered Cutlery Drawer  
(21" version shown)



**4WTCD-572HFL-1 & 4WTCD-572HFLSC-1**  
Full Access Tiered Cutlery Drawer  
(24" version shown)

**NOW YOU HAVE THE CHOICE!**  
**AVAILABLE WITH BLUM® CONCEALED SLIDES...OR PROVIDE YOUR OWN!**  
*Designed to be used with BLUMOTION 563H533 or Grass Elite 7523-16/550/533 concealed slides.*

Full Access Tiered Cutlery Drawer, w/ BLUMOTION Soft-Close							
PRODUCT	DESCRIPTION	DIMS	MCO	CAB	FINISH	SLP	
4WTCD-343HFLSC-1	Tiered Cutlery Drawer	13-1/2" (343 mm) W x 21-5/8" (550 mm) D x 4-5/16" (110 mm) H	13-1/2" (343 mm)	FLB15	Maple	\$291.45	
4WTCD-419HFLSC-1	Tiered Cutlery Drawer	16-1/2" (419 mm) W x 21-5/8" (550 mm) D x 4-5/16" (110 mm) H	16-1/2" (419 mm)	FLB18	Maple	\$319.00	
4WTCD-495HFLSC-1	Tiered Cutlery Drawer	19-1/2" (495 mm) W x 21-5/8" (550 mm) D x 4-5/16" (110 mm) H	19-1/2" (495 mm)	FLB21	Maple	\$345.25	
4WTCD-572HFLSC-1	Tiered Cutlery Drawer	22-1/2" (572 mm) W x 21-5/8" (550 mm) D x 4-5/16" (110 mm) H	22-1/2" (572 mm)	FLB24	Maple	\$361.35	
Full Access Tiered Cutlery Drawer - No Slides							
4WTCD-343HFL-1	Tiered Cutlery Drawer	13-1/32" (331 mm) W x 21" (533 mm) D x 3-3/4" (95 mm) H	N/A	FLB15	Maple	\$218.95	
4WTCD-419HFL-1	Tiered Cutlery Drawer	16-1/32" (407 mm) W x 21" (533 mm) D x 3-3/4" (95 mm) H	N/A	FLB18	Maple	\$252.60	
4WTCD-495HFL-1	Tiered Cutlery Drawer	19-1/32" (483 mm) W x 21" (533 mm) D x 3-3/4" (95 mm) H	N/A	FLB21	Maple	\$267.25	
4WTCD-572HFL-1	Tiered Cutlery Drawer	22-1/32" (560 mm) W x 21" (533 mm) D x 3-3/4" (95 mm) H	N/A	FLB24	Maple	\$312.35	
Face Frame Tiered Cutlery Drawer, w/ BLUMOTION Soft-Close							
4WTCD-15HSC-1	Tiered Cutlery Drawer	12" (305 mm) W x 21-3/4" (552 mm) D x 4-5/16" (110 mm) H	12" (305 mm)	FFB15	Maple	\$273.60	
4WTCD-18HSC-1	Tiered Cutlery Drawer	15" (381 mm) W x 21-3/4" (552 mm) D x 4-5/16" (110 mm) H	15" (381 mm)	FFB18	Maple	\$291.75	
4WTCD-21HSC-1	Tiered Cutlery Drawer	18" (457 mm) W x 21-3/4" (552 mm) D x 4-5/16" (110 mm) H	18" (457 mm)	FFB21	Maple	\$316.55	
4WTCD-24HSC-1	Tiered Cutlery Drawer	21" (533 mm) W x 21-3/4" (552 mm) D x 4-5/16" (110 mm) H	21" (533 mm)	FFB24	Maple	\$338.45	
Face Frame Tiered Cutlery Drawer - No Slides							
4WTCD-15H-1	Tiered Cutlery Drawer	11-1/2" (293 mm) W x 21" (533 mm) D x 3-3/4" (95 mm) H	N/A	FFB15	Maple	\$200.40	
4WTCD-18H-1	Tiered Cutlery Drawer	14-1/2" (369 mm) W x 21" (533 mm) D x 3-3/4" (95 mm) H	N/A	FFB18	Maple	\$240.25	
4WTCD-21H-1	Tiered Cutlery Drawer	17-1/2" (445 mm) W x 21" (533 mm) D x 3-3/4" (95 mm) H	N/A	FFB21	Maple	\$264.65	
4WTCD-24H-1	Tiered Cutlery Drawer	20-1/2" (521 mm) W x 21" (533 mm) D x 3-3/4" (95 mm) H	N/A	FFB24	Maple	\$282.60	

Waste  
 Blind Corner  
 Sink  
 Base  
 Tail  
 Drawer  
 Wall  
 Vanity  
 Closet  
 Susan  
 Lazy  
 LED Lighting





SCAN FOR PRICING!



- Designed for 30" and 36" base cabinet drawers
- Complete drawer system, just add your drawer front
- Easy installation
- Natural maple construction with semi-gloss finish
- Full-extension, BLUM soft-close undermount slides
- Drawer features up to (6) compartments and built-in knife organizer
- Sliding top tray features up to (6) compartments
- Mounts to cabinet side and rear wall
- Figure 8 door mounting brackets
- (1) Foil Wrap Insert
- Patented design (US Patent No. D843,791)
- TSCA Title VI compliant



4WTCD-876HFLSC-1



**4WTCD-724HFLSC-1 & 4WTCD-724HFL-1**  
Tiered Combination Drawer  
(Full Access 30" shown)



**4WTCD-36HFLSC-1 & 4WTCD-36HFL-1**  
Tiered Combination Drawer  
(Face Frame 36" shown)



Sliding top tray features up to (6) compartments



For video visit:  
[rev-a-shelf.com/videos](http://rev-a-shelf.com/videos)

### Full Access Tiered Combination Drawer w/ BLUMOTION Soft-Close

PRODUCT	DESCRIPTION	DIMS	MCO	CAB	FINISH	SLP
4WTCD-724HFLSC-1	Tiered Combination Drawer	28-1/2" (724 mm) W x 22-3/16" (564 mm) D x 4-7/16" (113 mm) H	28-1/2" (724 mm)	FLB30	Maple	\$554.50
4WTCD-876HFLSC-1	Tiered Combination Drawer	34-1/2" (876 mm) W x 22-3/16" (564 mm) D x 4-7/16" (113 mm) H	34-1/2" (876 mm)	FLB36	Maple	\$606.70

### Full Access Tiered Combination Drawer - No Slides

4WTCD-724HFL-1	Tiered Combination Drawer	28-1/32" (712 mm) W x 21" (533 mm) D x 3-3/4" (95 mm) H		FLB30	Maple	\$399.05
4WTCD-876HFL-1	Tiered Combination Drawer	34-1/32" (864 mm) W x 21" (533 mm) D x 3-3/4" (95 mm) H		FLB36	Maple	\$431.80

### Face Frame Tiered Combination Drawer w/ BLUMOTION Soft-Close

4WTCD-30HSC-1	Tiered Combination Drawer	27" (686 mm) W x 22-1/4" (565 mm) D x 4-5/16" (110 mm) H	27" (686 mm)	FFB30	Maple	\$538.95
4WTCD-36HSC-1	Tiered Combination Drawer	33" (838 mm) W x 22-1/4" (565 mm) D x 4-5/16" (110 mm) H	33" (838 mm)	FFB36	Maple	\$592.20

### Face Frame Tiered Combination Drawer - No Slides

4WTCD-30H-1	Tiered Combination Drawer	26-1/2" (674 mm) W x 21" (533 mm) D x 3-3/4" (95 mm) H		FFB30	Maple	\$334.65
4WTCD-36H-1	Tiered Combination Drawer	32-1/2" (826 mm) W x 21" (533 mm) D x 3-3/4" (95 mm) H		FFB36	Maple	\$387.45



SCAN FOR PRICING!

# Tiered K-Cup Drawer

## 4WTCD Series



- Designed for face frame 18" base cabinet drawers
- Complete drawer system, just add your drawer front
- Easy installation
- Natural maple construction with semi-gloss finish
- Full-extension, BLUM soft-close undermount slides
- Drawer features (8) compartments
- Sliding top tray holds (40) K-Cups
- Mounts to cabinet side and rear wall
- Figure 8 door mounting brackets
- Patented design (US Patent No. D789,750S1)
- TSCA Title VI compliant



4WTCD-18HSC-KCUP-1 & 4WTCD-18H-KCUP-1 Tiered K-Cup Drawer



For video visit: [rev-a-shelf.com/videos](http://rev-a-shelf.com/videos)

### Face Frame Tiered K-Cup Drawer w/ BLUMOTION Soft-Close

PRODUCT	DESCRIPTION	DIMS	MCO	CAB	FINISH	SLP
4WTCD-18HSC-KCUP-1	Tiered K-Cup Drawer	15" (381 mm) W x 21-3/4" (552 mm) D x 4-5/16" (110 mm) H	15" (381 mm)	FFB18	Maple	\$314.05

### Face Frame Tiered K-Cup Drawer - No Slides

4WTCD-18H-KCUP-1	K-Cup Drawer	14-1/2" (369 mm) W x 21" (533 mm) D x 3-3/4" (95 mm) H		FFB18	Maple	\$243.60
------------------	--------------	--	--	-------	-------	----------

Waste  
Blind Corner  
Sink  
Base  
Tail  
Drawer  
Wall  
Vanity  
Closet  
Susan  
Lazy  
LED Lighting

# 4WCCB Series

# Cut-Out Cutting Board Drawer



SCAN FOR PRICING!



- Designed for 18" cabinet drawers
- Natural maple construction with semi-gloss finish
- Removable, cut-out cutting board
- Removable, funnel insert
- Odor-reducing stopper
- Full-extension, BLUM soft-close undermount slides
- 5/8" drawer side walls
- Figure 8 door mounting brackets
- Drawer front (NOT) included
- Waste container (NOT) included
- TSCA Title VI compliant



Odor-reducing stopper



Removable food funnel for easy clean-up

4WCCB-419HFLSC-1



For video visit:  
[rev-a-shelf.com/videos](https://rev-a-shelf.com/videos)

## Full Access Cut-Out Cutting Board Drawer w/ TANDEM Slides

PRODUCT	DESCRIPTION	DIMS	MCO	CAB	FINISH	SLP
4WCCB-419HFLSC-1	Cut-Out Cutting Board Drawer	16-1/2" (419 mm) W x 21-5/8" (550 mm) D x 4-5/16" (110 mm) H	16-1/2" (419 mm)	FLB18	Maple	\$375.85

## Face Frame Cut-Out Cutting Board Drawer w/ TANDEM Slides

4WCCB-18HSC-1	Cut-Out Cutting Board Drawer	15" (381 mm) W x 21-3/4" (552 mm) D x 4-9/32" (109 mm) H	15" (521 mm)	FFB18	Maple	\$361.90
---------------	------------------------------	--	--------------	-------	-------	----------



SCAN FOR PRICING!

# Combination Knife Holder/Cutting Board Drawer

## 4KCB Series



- Designed for 18", 21" and 24" face frame and 18" full access base cabinet drawers
  - Face Frame fits 1-1/2"
  - Full Access fits 3/4"
- Complete drawer system, just add your drawer front
- Natural maple construction with semi-gloss finish
- Full-extension, BLUM soft-close undermount slides
- Up to (4) compartments and built-in knife organizer
- Mounts to cabinet drawer front, rear and side walls
- Figure 8 door mount brackets
- Built-in locking mechanism
- (1) wood cutting board
- Drawer front (NOT) included
- TSCA Title VI compliant

4KCB-419HFLSC-1



Top tier stores the included cutting board



**4KCB-21HSC-1**  
Combination Drawer  
(21" version shown)



**4KCB-18HSC-1**  
Combination Drawer  
(18" version shown)



For video visit:  
[rev-a-shelf.com/videos](http://rev-a-shelf.com/videos)

### Full Access Combination Knife Holder/ Cutting Board Drawer w/ BLUMOTION Soft-Close

PRODUCT	DESCRIPTION	DIMS	MCO	CAB	FINISH	SLP
4KCB-419HFLSC-1	Combination Drawer	16-1/2" (419 mm) W x 21-5/8" (550 mm) D x 4-3/8" (112 mm) H	16-1/2" (419 mm)	FLB18	Maple	\$369.00

### Combination Knife Holder/ Cutting Board Drawer w/ BLUMOTION Soft-Close

4KCB-18HSC-1	Combination Drawer	15" (381 mm) W x 21-3/4" (552 mm) D x 4-3/8" (112 mm) H	15" (381 mm)	FFB18	Maple	\$357.45
4KCB-21HSC-1	Combination Drawer	18" (457 mm) W x 21-3/4" (552 mm) D x 4-3/8" (112 mm) H	18" (457 mm)	FFB21	Maple	\$401.80
4KCB-24HSC-1	Combination Drawer	21" (533 mm) W x 21-3/4" (552 mm) D x 4-3/8" (112 mm) H	21" (533 mm)	FFB24	Maple	\$424.25

Waste  
Blind Corner  
Sink  
Base  
Tail  
Drawer  
Wall  
Vanity  
Closet  
Susan  
Lazy  
LED  
Lighting



SCAN FOR PRICING!



- Designed for 12", 15" and 18" vanity base cabinet drawers
- Complete drawer system, just add your drawer front
- Easy installation
- Natural maple construction with semi-gloss finish
- Full-extension, BLUM soft-close undermount slides
- Up to (7) compartments and up to (5) acrylic bins
- Non-skid vinyl lining
- Mounts to cabinet side and rear wall
- Figure 8 door mounting brackets
- TSCA Title VI compliant



4VDO-18SC-1



**4VDOHT-15SC-1**  
Half-Tier Vanity Drawer  
(15" Version Shown)



**4VDOHT-276FLSC-1**  
Tiered Vanity Drawer  
(12" Full Access Version Shown)



For video visit:  
[rev-a-shelf.com/videos](http://rev-a-shelf.com/videos)

### Full Access Vanity Drawer w/ BLUMOTION Soft-Close

PRODUCT	DESCRIPTION	DIMS	MCO	CAB	FINISH	SLP
4VDO-267FLSC-1	Single Drawer	10-1/2" (267 mm) W x 18-11/16" (475 mm) D x 4-5/16" (110 mm) H	10-1/2" (267 mm)	FLVB12	Maple	\$186.75
4VDOT-267FLSC-1	Tiered Drawer	10-1/2" (267 mm) W x 18-11/16" (475 mm) D x 8" (203 mm) H	10-1/2" (267 mm)	FLVB12	Maple	\$290.45
4VDOHT-267FLSC-1	Half-Tiered Drawer	10-1/2" (267 mm) W x 18-11/16" (475 mm) D x 8" (203 mm) H	10-1/2" (267 mm)	FLVB12	Maple	\$277.80
4VDO-343FLSC-1	Single Drawer	13-1/2" (343 mm) W x 18-11/16" (475 mm) D x 4-5/16" (110 mm) H	13-1/2" (343 mm)	FLVB15	Maple	\$217.80
4VDOT-343FLSC-1	Tiered Drawer	13-1/2" (343 mm) W x 18-11/16" (475 mm) D x 8" (203 mm) H	13-1/2" (343 mm)	FLVB15	Maple	\$332.90
4VDOHT-343FLSC-1	Half-Tiered Drawer	13-1/2" (343 mm) W x 18-11/16" (475 mm) D x 8" (203 mm) H	13-1/2" (343 mm)	FLVB15	Maple	\$305.95
4VDO-419FLSC-1	Single Drawer	16-1/2" (419 mm) W x 18-11/16" (475 mm) D x 4-5/16" (110 mm) H	16-1/2" (419 mm)	FLVB18	Maple	\$245.65
4VDOHT-419FLSC-1	Half-Tiered Drawer	16-1/2" (419 mm) W x 18-11/16" (475 mm) D x 8" (203 mm) H	16-1/2" (419 mm)	FLVB18	Maple	\$335.95

### Face Frame Vanity Drawer w/ BLUMOTION Soft-Close

4VDO-12SC-1	Single Drawer	9" (229 mm) W x 18-11/16" (475 mm) D x 4-5/16" (110 mm) H	9" (229 mm)	VB12	Maple	\$204.60
4VDOT-12SC-1	Tiered Drawer	9" (229 mm) W x 18-11/16" (475 mm) D x 8" (203 mm) H	9" (229 mm)	VB12	Maple	\$273.45
4VDOHT-12SC-1	Half-Tiered Drawer	9" (229 mm) W x 18-11/16" (475 mm) D x 8" (203 mm) H	9" (229 mm)	VB12	Maple	\$256.65
4VDO-15SC-1	Single Drawer	12" (305 mm) W x 18-11/16" (475 mm) D x 4-5/16" (110 mm) H	12" (305 mm)	VB15	Maple	\$207.05
4VDOT-15SC-1	Tiered Drawer	12" (305 mm) W x 18-11/16" (475 mm) D x 8" (203 mm) H	12" (305 mm)	VB15	Maple	\$314.20
4VDOHT-15SC-1	Half-Tiered Drawer	12" (305 mm) W x 18-11/16" (475 mm) D x 8" (203 mm) H	12" (305 mm)	VB15	Maple	\$289.00
4VDO-18SC-1	Single Drawer	15" (381 mm) W x 18-11/16" (475 mm) D x 4-5/16" (110 mm) H	15" (381 mm)	VB18	Maple	\$235.50
4VDOT-18SC-1	Tiered Drawer	15" (381 mm) W x 18-11/16" (475 mm) D x 8" (203 mm) H	15" (381 mm)	VB18	Maple	\$349.30
4VDOHT-18SC-1	Half-Tiered Drawer	15" (381 mm) W x 18-11/16" (475 mm) D x 8" (203 mm) H	15" (381 mm)	VB18	Maple	\$319.70



SCAN FOR PRICING!

# Wood Tambour Table

## 4TT Series



- Designed for 1-1/2" face frame 24" base cabinet drawers
- Complete drawer system, just add your drawer front
- Easy installation
- Natural maple construction with semi-gloss finish
- Over-extension, 220 lb. rated, table slides (static load)
- Adds 31-3/4" counter-top space
- Mounts to cabinet drawer rail and rear wall
- Patented door mount brackets with 5" of adjustability and micro-trim adjuster (US Patent No. 8,388,076)
- TSCA Title VI compliant

4TT-2133-1



**4TT-2133-1**  
Tambour Table



### Face Frame Wood Tambour Table

PRODUCT	DESCRIPTION	DIMS	MCO	CAB	FINISH	SLP
4TT-2133-1	Tambour Table	22" (559 mm) W x 19-15/16" (506 mm) D x 4-3/4" (121 mm) H	20-1/2" (521 mm) - FF 22" (559 mm) - FL	FFB24	Maple	\$539.10

# 4DP Series

# Drawer Peg System



SCAN FOR PRICING!



4DPS-WN-3021

- Designed for 42" or smaller base cabinet drawers
- Trim-to-fit existing drawer
- Drop-in installation
- Natural maple construction with semi-gloss finish, walnut construction with satin finish or natural maple construction with sound dampening vinyl covering
- Up to (120) pre-drilled peg holes
- (9), (12) or (16) matching, press-in pegs (maple and walnut only)
- Compatible with chrome accessories (sold separately)
- TSCA Title VI compliant



SCAN FOR PRICING!



Think outside the box



Perfect for vanities



Mix and match accessories for the perfect drawer solution



**4DPS-WN-2421**  
Drawer Peg System  
(Walnut version shown)



**4DPBG-3021-1**  
Drawer Peg Board  
(Vinyl finish shown)



**4DPS-3921**  
Drawer Peg System  
(Maple finish shown)



**4DPS-PEG-WN-4**  
(4) Wood Pegs  
(Walnut finish shown)



**DPS-PEG-4SS**  
(4) Stainless Steel Pegs



**5DCH-2-1-CR**  
(2) Stainless Steel Containers



**5DLD-1-CR**  
Lid Organizer



**5DCD-1-CR**  
Pot & Pan Organizer

### Drawer Peg System

PRODUCT	DESCRIPTION	DIMS	FINISH	SLP
4DPS-WN-2421	Peg System w/ (9) Pegs	24-1/4" (616 mm) W x 21-1/4" (540 mm) D x 6-5/8" (168 mm) H	Walnut	\$353.05
4DPS-WN-3021	Peg System w/ (12) Pegs	30-1/4" (768 mm) W x 21-1/4" (540 mm) D x 6-5/8" (168 mm) H	Walnut	\$455.30
4DPS-WN-3921	Peg System w/ (16) Pegs	39-1/4" (997 mm) W x 21-1/4" (540 mm) D x 6-5/8" (168 mm) H	Walnut	\$594.20
4DPS-2421	Peg System w/ (9) Pegs	24-1/4" (616 mm) W x 21-1/4" (540 mm) D x 6-5/8" (168 mm) H	Maple	\$142.10
4DPS-3021	Peg System w/ (12) Pegs	30-1/4" (768 mm) W x 21-1/4" (540 mm) D x 6-5/8" (168 mm) H	Maple	\$171.25
4DPS-3921	Peg System w/ (16) Pegs	39-1/4" (997 mm) W x 21-1/4" (540 mm) D x 6-5/8" (168 mm) H	Maple	\$222.00

### Drawer Peg Board - No Pegs

4DPBG-2421-1	Vinyl Drawer Peg Board	24-1/8" (613 mm) W x 21-1/4" (540 mm) D x 5/8" (16 mm) H	Vinyl	\$127.75
4DPBG-3021-1	Vinyl Drawer Peg Board	30-1/8" (765 mm) W x 21-1/4" (540 mm) D x 5/8" (16 mm) H	Vinyl	\$158.35
4DPBG-3921-1	Vinyl Drawer Peg Board	39-1/8" (994 mm) W x 21-1/4" (540 mm) D x 5/8" (16 mm) H	Vinyl	\$197.80
4DPB-2421	Drawer Peg Board	24-1/4" (616 mm) W x 21-1/4" (540 mm) D x 5/8" (16 mm) H	Maple	\$93.25
4DPB-3021	Drawer Peg Board	30-1/4" (769 mm) W x 21-1/4" (540 mm) D x 5/8" (16 mm) H	Maple	\$110.65
4DPB-3921	Drawer Peg Board	39-1/4" (997 mm) W x 21-1/4" (540 mm) D x 5/8" (16 mm) H	Maple	\$139.20

### Accessories

4DPS-PEG-4	(4) Maple Pegs	1-5/8" (41 mm) W x 1-5/8" (41 mm) D x 6-1/2" (165 mm) H	Maple	\$43.60
4DPS-PEG-WN-4	(4) Walnut Pegs	1-5/8" (41 mm) W x 1-5/8" (41 mm) D x 6-1/2" (165 mm) H	Walnut	\$101.00
DPS-PEG-4SS	(4) Stainless Steel Pegs	1-1/4" (32 mm) W x 1-1/4" (32 mm) D x 6" (153 mm) H	Stainless Steel	\$25.10
5DCH-2-1-CR	(2) Stainless Steel Containers	6-1/2" (165 mm) W x 10-1/4" (260 mm) D x 6-1/2" (165 mm) H	Stainless Steel	\$68.75
5DLD-1-CR	Lid Organizer	5-1/4" (133 mm) W x 16-7/8" (429 mm) D x 5-3/8" (137 mm) H	Chrome	\$35.25
5DCD-1-CR	Pot/Pan Organizer	7-3/4" (197 mm) W x 15-1/4" (387 mm) D x 7-5/8" (194 mm) H	Chrome	\$47.25

Waste  
Blind Corner  
Sink  
Base  
Tail  
Drawer  
Wall  
Vanity  
Closet  
Susan  
LED Lighting



# 4WCT Series

# Wood Cutlery Tray Insert



SCAN FOR PRICING!



4WCT-WN-1SH/ 4WD-22SH-WN-1

- Designed for 24" or smaller base cabinet drawers
- Trim-to-fit existing drawer
- Drop-in installation
- Natural maple construction with semi-gloss finish or walnut construction with satin finish
- Up to (9) compartments
- Shallow height sizes available
- Compatible with 4WD Wood Divider (Pg. 221) when using multiple inserts
- TSCA Title VI compliant



For video visit:  
[rev-a-shelf.com/videos](https://rev-a-shelf.com/videos)

Waste

Blind Corner

Sink

Base

Tall

Drawer

Wall

Vanity

Closet

Lazy Susan

LED Lighting



SCAN FOR PRICING!



**4WCT-3SH**  
Wood Cutlery Tray Insert  
(Maple finish shown)



**4WCT-1SH**  
Wood Cutlery Tray Insert  
(Walnut finish shown)

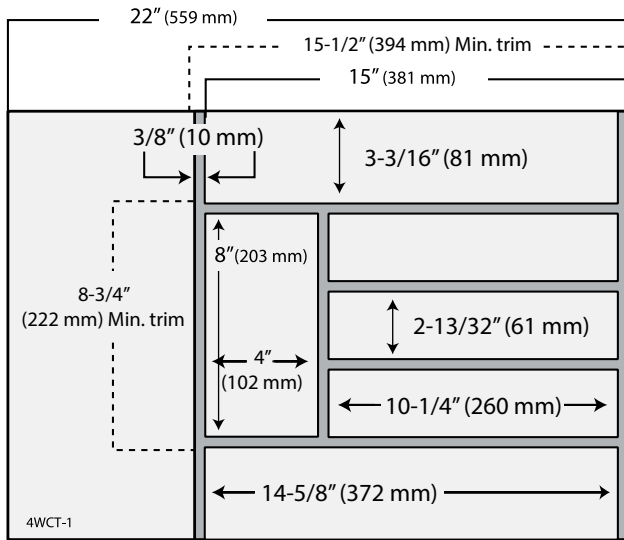

**4WCT-1**

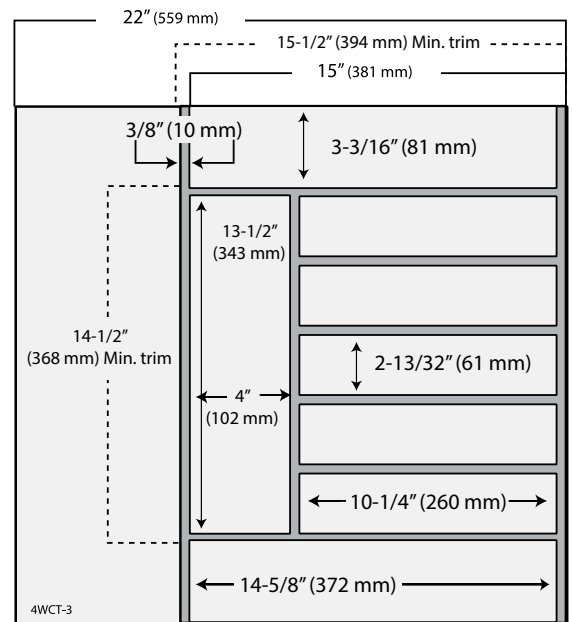

**4WCT-3**

**Shallow Wood Cutlery Tray Insert**

PRODUCT	DESCRIPTION	DIMS	FINISH	SLP
4WCT-WN-1SH	Shallow Height Cutlery Tray	15-1/8" (384 mm) W x 22" (559 mm) D x 2-3/8" (60 mm) H	Walnut	\$179.05
4WCT-WN-3SH	Shallow Height Cutlery Tray	21-1/8" (537 mm) W x 22" (559 mm) D x 2-3/8" (60 mm) H	Walnut	\$242.15
4WCT-1SH	Shallow Height Cutlery Tray	14-5/8" (371 mm) W x 22" (559 mm) D x 2-3/8" (60 mm) H	Maple	\$82.35
4WCT-3SH	Shallow Height Cutlery Tray	20-5/8" (524 mm) W x 22" (559 mm) D x 2-3/8" (60 mm) H	Maple	\$107.60

**Wood Cutlery Tray Insert**

4WCT-1	Cutlery Tray	14-5/8" (371 mm) W x 22" (559 mm) D x 2-7/8" (73 mm) H	Maple	\$98.00
4WCT-3	Cutlery Tray	20-5/8" (524 mm) W x 22" (559 mm) D x 2-7/8" (73 mm) H	Maple	\$130.35



SCAN FOR PRICING!



For video visit:  
[rev-a-shelf.com/videos](http://rev-a-shelf.com/videos)

- Designed for 36" or smaller base cabinet drawers
- Trim-to-fit existing drawer
- Drop-in installation
- Natural maple construction with semi-gloss finish or walnut construction with satin finish
- Up to (2) adjustable compartments
- Up to (12) static compartments
- Shallow height sizes available
- Compatible with 4FWI Foil Wrap Insert and 4WD Wood Divider (Pg. 221)
- TSCA Title VI compliant

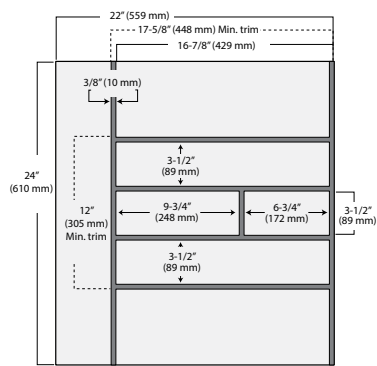

4WUT-3

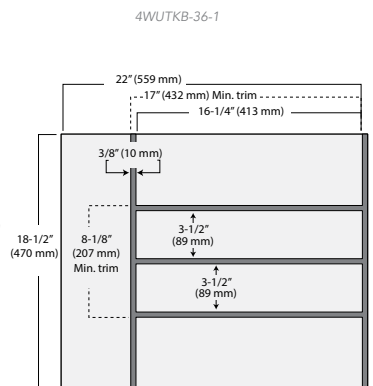

4WUT-1



4FWI-16SS-1  
 Foil Wrap Insert



SCAN FOR PRICING!



**4WUT-WN-1SH**  
Wood Utensil Tray Insert  
(Walnut finish shown)



**4WUT-36-1**  
Wide Utensil Drawer Insert



**4WUTCT-36-1**  
Wide Utensil/Cutlery  
Drawer Insert



**4WUTKB-36-1**  
Wide Knife Block/Utensil  
Drawer Insert

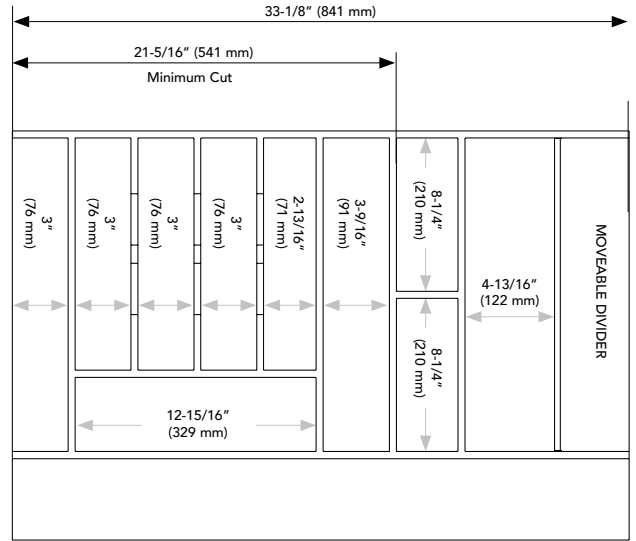

**4WUTCT-36-1**

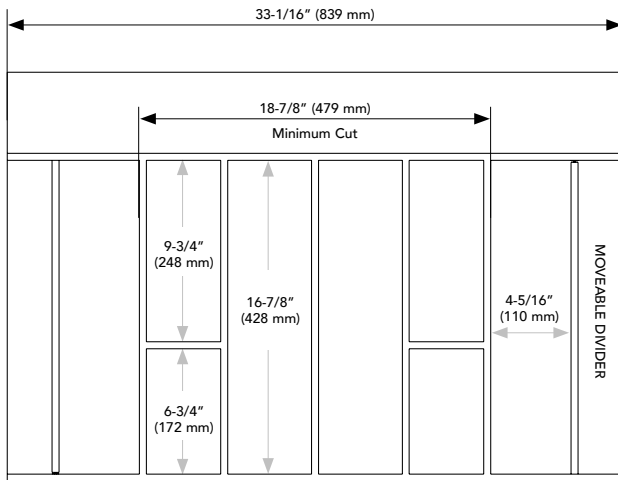

**4WUT-36-1**

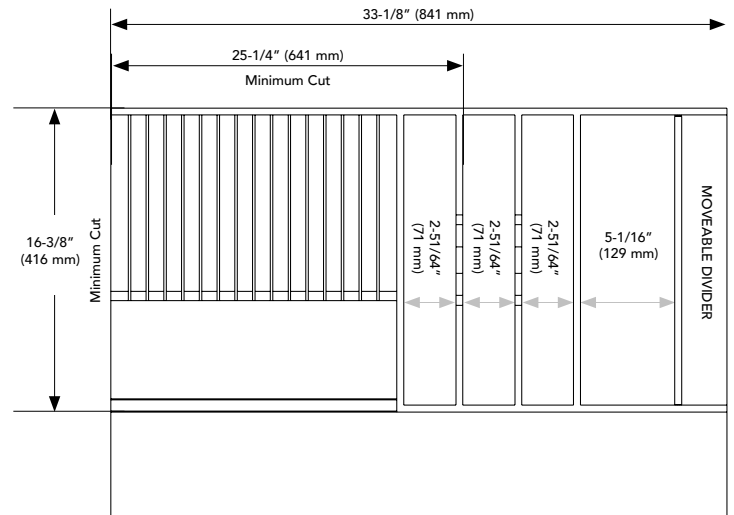

**4WUTKB-36-1**

**Shallow Wood Utensil Tray Insert**

PRODUCT	DESCRIPTION	DIMS	FINISH	SLP
4WUT-WN-1SH	Shallow Height Utensil Tray	15-1/8" (384 mm) W x 22" (559 mm) D x 2-3/8" (60 mm) H	Walnut	\$169.05
4WUT-WN-3SH	Shallow Height Utensil Tray	21-1/8" (537 mm) W x 22" (559 mm) D x 2-3/8" (60 mm) H	Walnut	\$229.10
4WUT-1SH	Shallow Height Utensil Tray	18-1/2" (470 mm) W x 22" (559 mm) D x 2-3/8" (60 mm) H	Maple	\$98.45
4WUT-3SH	Shallow Height Utensil Tray	24" (610 mm) W x 22" (559 mm) D x 2-3/8" (60 mm) H	Maple	\$120.05

**Wood Utensil Tray Insert**

4WUT-1	Utensil Tray	18-1/2" (470 mm) W x 22" (559 mm) D x 2-7/8" (73 mm) H	Maple	\$102.65
4WUT-3	Utensil Tray	24" (610 mm) W x 22" (559 mm) D x 2-7/8" (73 mm) H	Maple	\$130.80

**Wide Drawer Inserts**

4WUT-36-1	Utensil Drawer Insert	33-1/8" (841 mm) W x 22" (559 mm) D x 2-7/8" (73 mm) H	Maple	\$215.45
4WUTKB-36-1	Knife Block/Utensil Drawer Insert	33-1/8" (841 mm) W x 22" (559 mm) D x 2-7/8" (73 mm) H	Maple	\$279.55
4WUTCT-36-1	Utensil/Cutlery Drawer Insert	33-1/8" (841 mm) W x 22" (559 mm) D x 2-7/8" (73 mm) H	Maple	\$221.70

**Accessories**

4FWI-16SS-1	16" Foil Wrap Insert for 4WUT	3-7/16" (87 mm) W x 16" (406 mm) D x 2-5/8" (67 mm) H	Stainless Steel	\$43.65
-------------	-------------------------------	---	-----------------	---------

Waste  
Blind Corner  
Sink  
Base  
Tail  
Drawer  
Wall  
Vanity  
Closet  
Susan  
Lazy  
Lighting  
LED



SCAN FOR PRICING!

- Designed for 36" or smaller base cabinet drawers
- Trim-to-fit existing drawer
- Drop-in installation
- Natural maple construction with semi-gloss finish or walnut construction with satin finish
- (1) rear compartment and up to (3) tiers
- Compatible with 4WD Wood Divider (Pg. 221) when using multiple inserts
- TSCA Title VI compliant

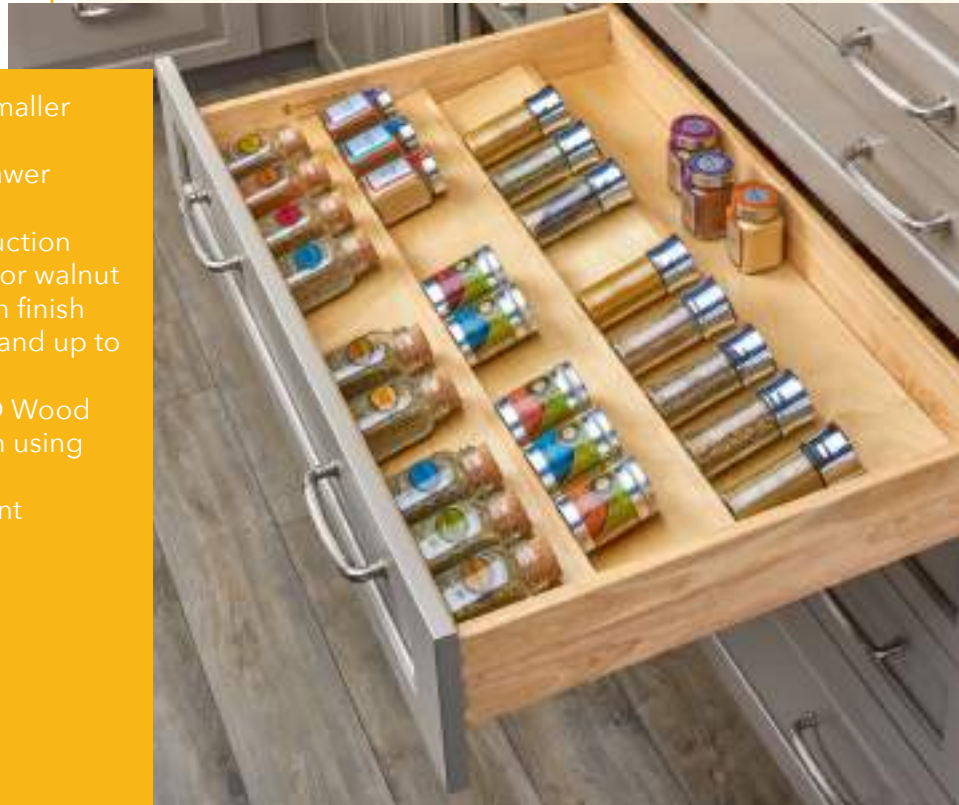

4SDI-36-1



**4SDI-WN-18-1**  
Wood Spice Drawer Insert  
*(Walnut finish shown)*

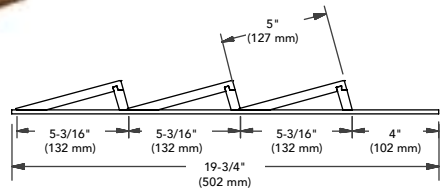

For video visit:  
[rev-a-shelf.com/videos](http://rev-a-shelf.com/videos)

### Wood Spice Drawer Insert

PRODUCT	DESCRIPTION	DIMS	FINISH	SLP
4SDI-WN-18-1	Spice Drawer Insert	16" (76 - 406 mm) W x 19-3/4" (502 mm) D x 1-17/32" (39 mm) H	Walnut	\$132.65
4SDI-WN-24-1	Spice Drawer Insert	22" (76 - 559 mm) W x 19-3/4" (502 mm) D x 1-17/32" (39 mm) H	Walnut	\$172.25
4SDI-18	Spice Drawer Insert	16" (76 - 406 mm) W x 19-3/4" (502 mm) D x 1-17/32" (39 mm) H	Maple	\$106.70
4SDI-24	Spice Drawer Insert	22" (76 - 559 mm) W x 19-3/4" (502 mm) D x 1-17/32" (39 mm) H	Maple	\$139.65

### Wide Spice Drawer Insert

4SDI-36-1	Spice Drawer Insert	33-1/8" (841 mm) W x 19-3/4" (502 mm) D x 1-3/4" (44 mm) H	Maple	\$204.75
-----------	---------------------	--	-------	----------



SCAN FOR PRICING!

# Wood K-Cup Drawer Insert

## 4CDI Series



4CDI-18-KCUP-1

- Designed for 18" and 24" base cabinet drawers
- Trim-to-fit existing drawer
- Drop-in installation
- Natural maple construction with semi-gloss finish
- Up to (4) compartments and (5) tiers that hold up to (30) K-Cups
- Compatible with 4WD Wood Divider (Pg. 221) when using multiple inserts
- TSCA Title VI compliant



**4CDI-24-KCUP-1**  
Wood K-CUP Drawer Insert  
(24" version shown)

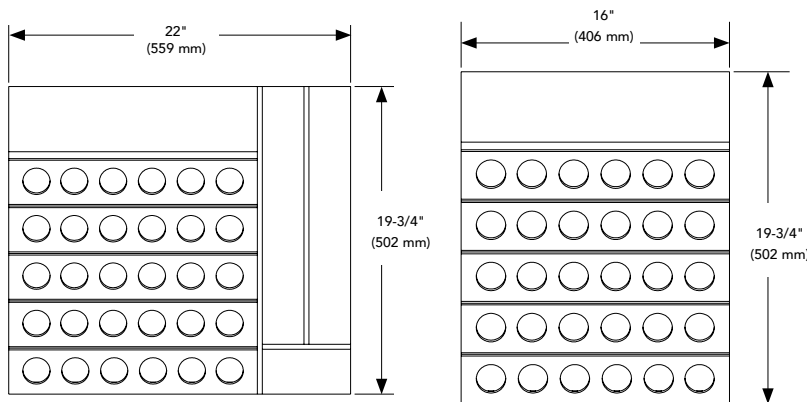

4CDI-24-KCUP-1

4CDI-18-KCUP-1



For video visit:  
[rev-a-shelf.com/videos](https://rev-a-shelf.com/videos)

### Wood K-Cup Drawer Insert

PRODUCT	DESCRIPTION	DIMS	FINISH	SLP
4CDI-18-KCUP-1	K-Cup Tray Insert	16" (406 mm) W x 19-3/4" (502 mm) D x 2-3/8" (60 mm) H	Maple	\$130.65
4CDI-24-KCUP-1	K-Cup Tray Insert	22" (559 mm) W x 19-3/4" (502 mm) D x 2-3/8" (60 mm) H	Maple	\$160.10

Waste  
Blind Corner  
Sink  
Base  
Tail  
Drawer  
Wall  
Vanity  
Closet  
Lazy Susan  
LED Lighting

# 4WDKB Series

## Double Knife Block Insert



SCAN FOR PRICING!

- Designed for 18-1/2" or smaller base cabinet drawers
- Trim-to-fit existing drawer
- Drop-in installation
- Natural maple construction with semi-gloss finish or walnut construction with satin finish
- (1) compartment and (2) tiers that include up to (55) knife slots
- Compatible with 4WD Wood Divider (Pg. 221) when using multiple inserts
- TSCA Title VI compliant



For video visit:  
[rev-a-shelf.com/videos](http://rev-a-shelf.com/videos)



**4WDKB-WN-1**  
 Wood Double Knife Block  
 (Walnut finish shown)

4WDKB-1

### Wood Double Knife Block Insert

PRODUCT	DESCRIPTION	DIMS	FINISH	SLP
4WDKB-WN-1	Double Knife Block Insert	18-1/2" (470 mm) W x 22" (457 - 559 mm) D x 2" (51 mm) H	Walnut	\$483.45
4WDKB-1	Double Knife Block Insert	18-1/2" (470 mm) W x 22" (457 - 559 mm) D x 2" (51 mm) H	Maple	\$170.25

# LD-4CT Series

## Adjustable Wood Drawer Organizer

- Designed for 15" and 21" base cabinet drawers
- Fits into existing drawer
- Drop-in installation
- Maple construction with semi-gloss clear finish
- Up to (13) dividers
- Customizable, press-in clips: 15" includes (18), 21" includes (26)
- TSCA Title VI compliant



LD-4CT15-1

### Wood Drawer Organizer

PRODUCT	DESCRIPTION	DIMS	FINISH	SLP
LD-4CT15-1	Drawer Organizer	9-7/8" (251 mm) W x 19-1/8" (486 mm) D x 2-1/2" (64 mm) H	Maple	\$62.20
LD-4CT21-1	Drawer Organizer	15-3/8" (391 mm) W x 19-1/8" (486 mm) D x 2-1/2" (64 mm) H	Maple	\$91.50



SCAN FOR PRICING!

# Wood Knife Block Insert

## 4WKB Series



- Designed for 18-1/2" or smaller base cabinet drawers
- Trim-to-fit existing drawer
- Drop-in installation
- Natural maple construction with semi-gloss finish
- (1) compartment and up to (19) knife slots
- Compatible with 4WD Wood Divider when using multiple inserts
- TSCA Title VI compliant

### Wood Knife Block Insert

PRODUCT	DESCRIPTION	DIMS	FINISH	SLP
4WKB-1	Knife Block Insert	18-1/2" (470 mm) W x 22" (559 mm) D x 2-3/8" (60 mm) H	Maple	\$136.30

# Wood Drawer Divider

## 4WD Series



4WD-22-1

- Designed for 22" D or smaller base cabinet drawers
- Trim-to-fit existing drawer
- Natural maple construction with semi-gloss finish or walnut construction with satin finish
- 2-3/8" shallow H or 2-7/8" H
- Compatible with 4WCT, 4WUT, 4WKB and 4SDI Inserts
- Easily combine various drawer inserts into wider drawer
- TSCA Title VI compliant

### Shallow Height Wood Drawer Divider

PRODUCT	DESCRIPTION	DIMS	FINISH	SLP
4WD-22SH-WN-1	Shallow Height Divider	1/2" (13 mm) W x 22" (559 mm) D x 2-3/8" (60 mm) H	Walnut	\$39.75
4WD-22SH-1	Shallow Height Divider	1/2" (13 mm) W x 22" (559 mm) D x 2-3/8" (60 mm) H	Maple	\$15.65

### Wood Drawer Divider

4WD-22-1	Divider	1/2" (13 mm) W x 22" (559 mm) D x 2-7/8" (73 mm) H	Maple	\$15.80
----------	---------	--	-------	---------





SCAN FOR PRICING!

- Designed for 24" or smaller base cabinet drawers
- Trim-to-fit existing drawer
- Drop-in installation
- Polystyrene construction with textured finish in white or almond, or glossy finish in white or metallic silver
- Up to (7) compartments
- Great for our outdoor applications



CT-2W-52



**CT-1A-52**  
Polymer Cutlery Tray  
*(Almond finish shown)*



**GCT-2S-52**  
Polymer Cutlery Tray  
*(Metallic Silver finish shown)*



**CT-4W-52**  
Polymer Cutlery Tray  
*(White finish shown)*

**NOTE:** Trays can be ordered trimmed to your specifications for an additional charge. Ships with a clear protective coating; remove before use.

Polymer \* - Insert (W) for White and (A) for Almond  
Glossy Polymer - \* (W) for White and (S) For Metallic Silver.

### Polymer Cutlery Tray

PRODUCT	DESCRIPTION	DIMS	MIN TRIM	FINISH	SLP
CT-1*-52	Cutlery Tray	11-1/2" (293 mm) W x 21-1/4" (540 mm) D x 2-3/8" (61 mm) H	8-5/8" (219 mm) W x 17-3/4" (451 mm) D	Polymer	\$18.40
CT-2*-52	Cutlery Tray	14-1/4" (362 mm) W x 21-1/4" (540 mm) D x 2-3/8" (61 mm) H	11-5/8" (296 mm) W x 17-3/4" (451 mm) D	Polymer	\$20.15
CT-3*-52	Cutlery Tray	17-1/2" (445 mm) W x 21-1/4" (540 mm) D x 2-3/8" (61 mm) H	14-3/4" (375 mm) W x 17-3/4" (451 mm) D	Polymer	\$23.65
CT-4*-52	Cutlery Tray	21-7/8" (556 mm) W x 21-1/4" (540 mm) D x 2-3/8" (61 mm) H	18-3/4" (467 mm) W x 17-3/4" (451 mm) D	Polymer	\$24.80
CT-1*-10	(10) Cutlery Trays	11-1/2" (293 mm) W x 21-1/4" (540 mm) D x 2-3/8" (61 mm) H	8-5/8" (219 mm) W x 17-3/4" (451 mm) D	Polymer	\$13.80 ea.
CT-2*-20	(20) Cutlery Trays	14-1/4" (362 mm) W x 21-1/4" (540 mm) D x 2-3/8" (61 mm) H	11-5/8" (296 mm) W x 17-3/4" (451 mm) D	Polymer	\$14.20 ea.
CT-3*-20	(20) Cutlery Trays	17-1/2" (445 mm) W x 21-1/4" (540 mm) D x 2-3/8" (61 mm) H	14-3/4" (375 mm) W x 17-3/4" (451 mm) D	Polymer	\$16.55 ea.
CT-4*-10	(10) Cutlery Trays	21-7/8" (556 mm) W x 21-1/4" (540 mm) D x 2-3/8" (61 mm) H	18-3/4" (467 mm) W x 17-3/4" (451 mm) D	Polymer	\$16.95 ea.

### Glossy Polymer Cutlery Tray

GCT-1*-52	Cutlery Tray	11-1/2" (293 mm) W x 21-1/4" (540 mm) D x 2-3/8" (61 mm) H	8-5/8" (219 mm) W x 17-3/4" (451 mm) D	Polymer	\$24.80
GCT-2*-52	Cutlery Tray	14-1/4" (362 mm) W x 21-1/4" (540 mm) D x 2-3/8" (61 mm) H	11-5/8" (296 mm) W x 17-3/4" (451 mm) D	Polymer	\$26.85
GCT-3*-52	Cutlery Tray	17-1/2" (445 mm) W x 21-1/4" (540 mm) D x 2-3/8" (61 mm) H	14-3/4" (375 mm) W x 17-3/4" (451 mm) D	Polymer	\$31.30
GCT-4*-52	Cutlery Tray	21-7/8" (556 mm) W x 21-1/4" (540 mm) D x 2-3/8" (61 mm) H	18-3/4" (467 mm) W x 17-3/4" (451 mm) D	Polymer	\$33.35
GCT-1*-10	(10) Cutlery Trays	11-1/2" (293 mm) W x 21-1/4" (540 mm) D x 2-3/8" (61 mm) H	8-5/8" (219 mm) W x 17-3/4" (451 mm) D	Polymer	\$17.25 ea.
GCT-2*-20	(20) Cutlery Trays	14-1/4" (362 mm) W x 21-1/4" (540 mm) D x 2-3/8" (61 mm) H	11-5/8" (296 mm) W x 17-3/4" (451 mm) D	Polymer	\$17.70 ea.
GCT-3*-20	(20) Cutlery Trays	17-1/2" (445 mm) W x 21-1/4" (540 mm) D x 2-3/8" (61 mm) H	14-3/4" (375 mm) W x 17-3/4" (451 mm) D	Polymer	\$20.60 ea.
GCT-4*-10	(10) Cutlery Trays	21-7/8" (556 mm) W x 21-1/4" (540 mm) D x 2-3/8" (61 mm) H	18-3/4" (467 mm) W x 17-3/4" (451 mm) D	Polymer	\$21.00 ea.



SCAN FOR PRICING!

# Polymer Utensil Tray

## UT/GUT Series



- Designed for 24" or smaller base cabinet drawers
- Trim-to-fit existing drawer
- Drop-in installation
- Polystyrene construction with textured or glossy finish in white, or textured finish in almond
- Up to (4) compartments
- Great for our outdoor applications

GUT-18W-52



**UT-10A-52**

Polymer Utensil Tray  
*(Almond finish shown)*

**UT-12A-52**

Polymer Utensil Tray  
*(Almond finish shown)*

**GUT-15W-52**

Polymer Utensil Tray  
*(White finish shown)*

**NOTE:** Trays can be ordered trimmed to your specifications for an additional charge. Ships with a clear protective coating; remove before use.

\* - Insert (W) for White, (A) for Almond. Add "G" to the beginning of the product number to designate Glossy finish.

### Polymer Utensil Tray

PRODUCT	DESCRIPTION	DIMS	MIN TRIM	FINISH	SLP
UT-10*-52	Utensil Tray	11-1/2" (293 mm) W x 21-1/4" (540 mm) D x 2-3/8" (61 mm) H	8-5/8" (219 mm) W x 17-3/4" (451 mm) D	Polymer	\$29.15
UT-12*-52	Utensil Tray	14-1/4" (362 mm) W x 21-1/4" (540 mm) D x 2-3/8" (61 mm) H	11-5/8" (296 mm) W x 17-3/4" (451 mm) D	Polymer	\$28.00
UT-15*-52	Utensil Tray	17-1/2" (445 mm) W x 21-1/4" (540 mm) D x 2-3/8" (61 mm) H	14-3/4" (375 mm) W x 17-3/4" (451 mm) D	Polymer	\$28.40
UT-18*-52	Utensil Tray	21-7/8" (556 mm) W x 21-1/4" (540 mm) D x 2-3/8" (61 mm) H	18-3/8" (467 mm) W x 17-3/4" (451 mm) D	Polymer	\$35.50

### Polymer Utensil Trays

UT-10*-10	(10) Utensil Trays	11-1/2" (293 mm) W x 21-1/4" (540 mm) D x 2-3/8" (61 mm) H	8-5/8" (219 mm) W x 17-3/4" (451 mm) D	Polymer	\$16.40 ea.
UT-12*-20	(20) Utensil Trays	14-1/4" (362 mm) W x 21-1/4" (540 mm) D x 2-3/8" (61 mm) H	11-5/8" (296 mm) W x 17-3/4" (451 mm) D	Polymer	\$16.95 ea.
UT-15*-20	(20) Utensil Trays	17-1/2" (445 mm) W x 21-1/4" (540 mm) D x 2-3/8" (61 mm) H	14-3/4" (375 mm) W x 17-3/4" (451 mm) D	Polymer	\$19.70 ea.
UT-18*-10	(10) Utensil Trays	21-7/8" (556 mm) W x 21-1/4" (540 mm) D x 2-3/8" (61 mm) H	18-3/8" (467 mm) W x 17-3/4" (451 mm) D	Polymer	\$27.85 ea.

Waste  
Blind Corner  
Sink  
Base  
Tail  
Drawer  
Wall  
Vanity  
Closet  
Susan  
Lazy  
LED Lighting



SCAN FOR  
PRICING!

- Designed for 48" or smaller base cabinet drawers
- Trim-to-fit existing drawer
- Drop-in installation
- Polystyrene construction with textured finish, almond or white
- Up to (4) tiers
- Great for our outdoor applications



ST50-21W-52



**ST50-21A-52**  
Polymer Spice Tray  
(Almond finish shown)

**NOTE:** Trays can be ordered trimmed to your specifications for an additional charge. Ships with a clear protective coating; remove before use.

\* - Insert (W) for White, (A) for Almond

#### Polymer Spice Tray

PRODUCT	DESCRIPTION	DIMS	FINISH	SLP
ST50-21*-52	Spice Tray	50" (1270 mm) W x 21" (534 mm) D x 1-7/8" (48 mm) H	Polymer	\$72.05
<b>(12) Polymer Spice Trays</b>				
ST50-21*-12	Spice Tray	50" (1270 mm) W x 21" (534 mm) D x 1-7/8" (48 mm) H	Polymer	\$63.80 ea.



SCAN FOR PRICING!

# Bread Drawer Cover

## BDC Series



- Designed for 24" or smaller base cabinet drawers
- Trim-to-fit existing drawer
- Easy installation
- Textured polymer available in almond, translucent or white
- Molded-in handle and rear stop
- Includes sliding rails and mounting screws

BDC-200-20



**BDC24-11**  
Polymer Bread Drawer Cover  
(White finish shown)



**BDC24-15**  
Polymer Bread Drawer Cover  
(Almond finish shown)

**NOTE:** Cover is textured to hide scratches. Product available in three colors. These bread drawer covers can be ordered custom cut to your drawer specifications.

\*\* - Insert (11) for White, (15) for Almond and (20) for Translucent (for an additional cost).

Polymer Bread Drawer Cover					
PRODUCT	DESCRIPTION	DIMS	MIN TRIM	FINISH	SLP
BDC-200-**	BDC Kit	16-3/4" (426 mm) W x 21-3/4" (553 mm) D x 3/8" (10 mm) H	11-5/8" (295 mm) x Any Depth	Polymer	\$45.10
BDC-200-20	BDC Kit-Translucent w/ Clear Rails	16-3/4" (295 - 425 mm) W x 21-3/4" (552 mm) D x 3/8" (10 mm) H	11-5/8" (295 mm) x Any Depth	Polymer	\$73.80
Polymer Bread Drawer Cover					
BDC24-**	BDC Kit	20-3/8" (518 mm) W x 21-3/4" (553 mm) D x 3/8" (10 mm) H	16-1/16" (408 mm) x Any Depth	Polymer	\$44.10
BDC24-20	BDC Kit-Translucent w/ Clear Rails	20-3/8" ( 511 mm) W x 21-3/4" (552 mm) D x 3/8" (10 mm) H	16-1/16" (408 mm) x Any Depth	Polymer	\$73.95
F-Channel Rail Kit					
CDR-21W-A	Extra White Rails			White	\$22.75
CDR-21A-A	Extra Almond Rails			Almond	\$22.75
CDR-21C-A	Extra Clear Rails			Clear	\$28.70

# RAS-FDSM Series

## Pullout File Drawer System



SCAN FOR PRICING!

- Designed for 18" base cabinet with 1-1/2" face frame
- Complete drawer system
- Easy installation
- Pre-assembled door mount brackets
- Chrome-plated wire construction
- Full-extension, ball-bearing, 100 lb. slides
- Stores either letter or legal sizes
- Mounts to cabinet side wall



Two units shown

RAS-FDSM-DM15-1

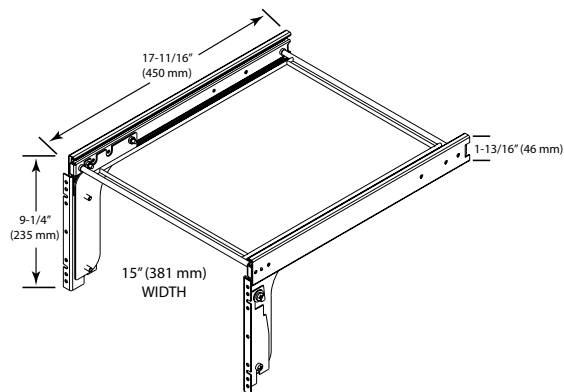

### Pullout File Drawer System

PRODUCT	DESCRIPTION	DIMS	MCO	CAB	FINISH	SLP
RAS-FDSM-DM15-1	Drawer System	15" (381 mm) W x 17-3/4" (451 mm) D x 10-1/2" (267 mm) H	15" (381 mm)	B18	Polymer	\$93.80



SCAN FOR PRICING!

# Two-Tier File Drawer System

## RAS-FD Series



**RAS-FD-KIT**  
Pullout File Drawer System

- Designed for a standard height base 18" drawer/door cabinet
- Features full-extension, ball-bearing slides
- Heavy duty chrome plated rails
- Can store both letter and legal folders
- Door mounting brackets (sold separately)

### Two-Tier File Drawer System

PRODUCT	DESCRIPTION	DIMS	MCO	CAB	FINISH	PRICE
RAS-FD-KIT	File Drawer System	14-3/4" (375 mm) W x 19-3/4 - 24" (502 - 610 mm) D x 22-5/8" (575 mm) H	14-1/2" (368 mm) - FF 14-7/8" (378 mm) - FL	B18	Chrome	\$168.35
RV-DM-FDKIT	(2) Door Mounting Kit				Silver	\$58.00

# File Drawer System



RAS-SMFD-52

## RAS-\*\*FD Series

- Designed for 18" and 21" base cabinet drawers
- Fits into existing drawer
- Drop-in installation
- Black, powder-coated wire construction
- RAS-LGFD includes T-rod connectors to store legal and letter sizes

### File Drawer System

PRODUCT	DESCRIPTION	DIMS	MCO	CAB	FINISH	PRICE
RAS-SMFD-52	File System-Letter	13" (330 mm) W x 19-1/4" (489 mm) D x 9-3/4" (248 mm) H	15" (381 mm)	B18	Black	\$32.20
RAS-LGFD-52	File System-Legal	15-7/8" (403 mm) W x 19-1/4" (489 mm) D x 9-3/4" (248 mm) H	18" (457 mm)	B21	Black	\$35.65

Waste  
Blind Corner  
Sink  
Base  
Tail  
Drawer  
Wall  
Vanity  
Closet  
Susan  
Lazy  
LED Lighting